

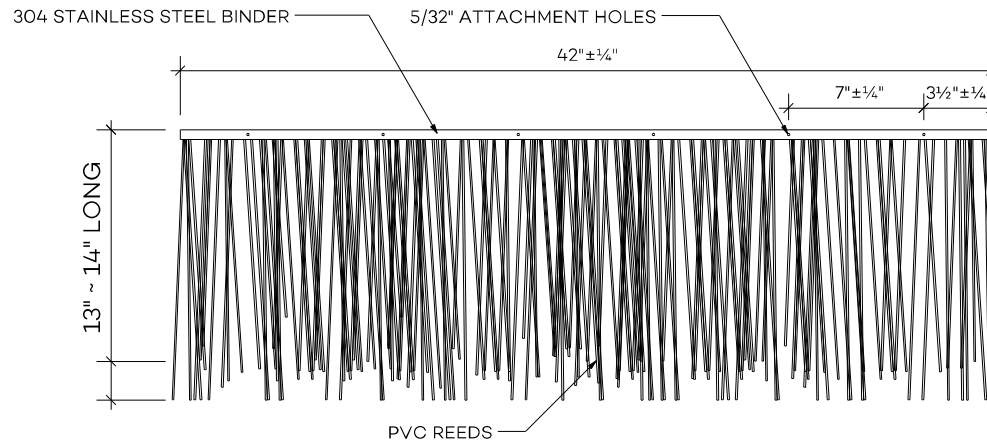

Somerset

Field Shingle Detail



FIELD SHINGLE DETAIL

SOMERSET FIELD SHINGLE

SHIPPING:
16 PCS PER BOX

COLOR:
STANDARD: FADED KHAKI

STANDARD COURSE EXPOSURE:
6-1/2 INCHES

PART NUMBERS:
734274 - Somerset - Field Shingle - Faded Khaki



Global Innovation
313 SW Windswept Glen
Lake City, FL 32024
1-877-784-2824 | endureed.com





Hip Shingle Detail

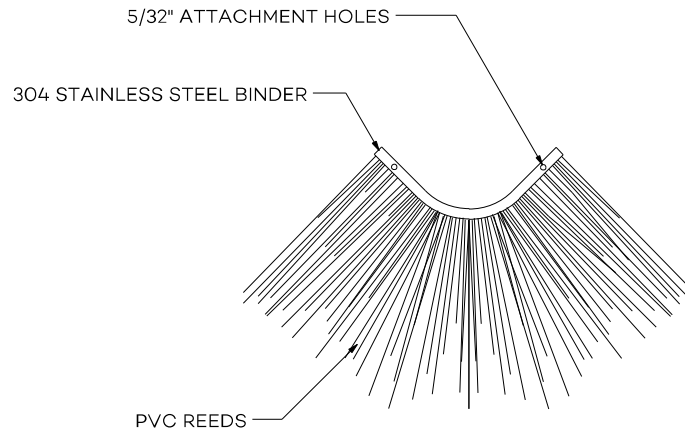

HIP SHINGLE DETAIL

PART NUMBER:

734287 - Somerset - Hip Shingle - Khaki

Global Innovation
313 SW Windswept Glen
Lake City, FL 32024
1-877-784-2824 | endureed.com





Ceiling Shingle Detail

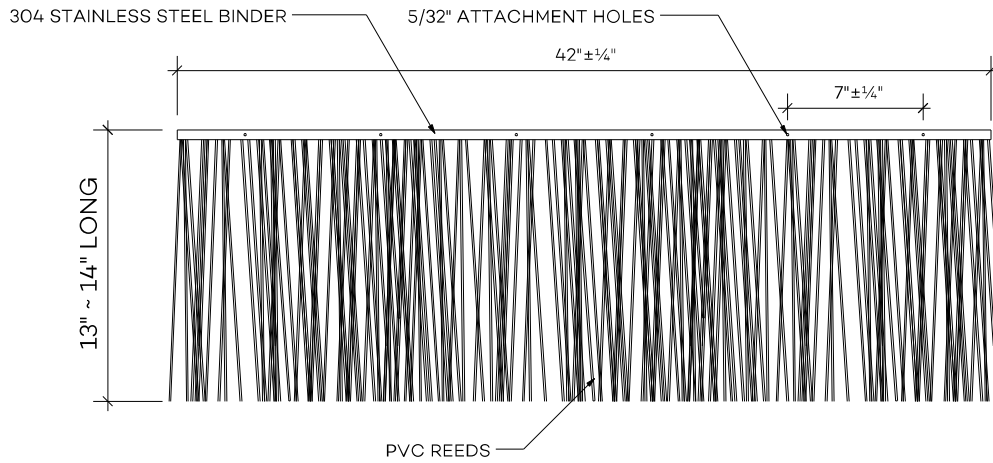

CEILING SHINGLE DETAIL

PART NUMBER:

734286 - Somerset - Ceiling Shingle - Khaki

Global Innovation
313 SW Windswept Glen
Lake City, FL 32024
1-877-784-2824 | endureed.com



CORNER EAVE WADD:

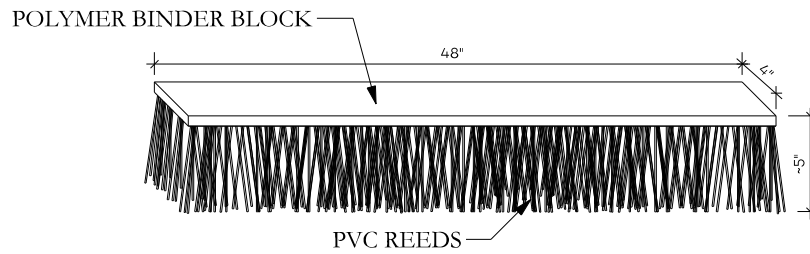

SOMERSET EAVE WADD

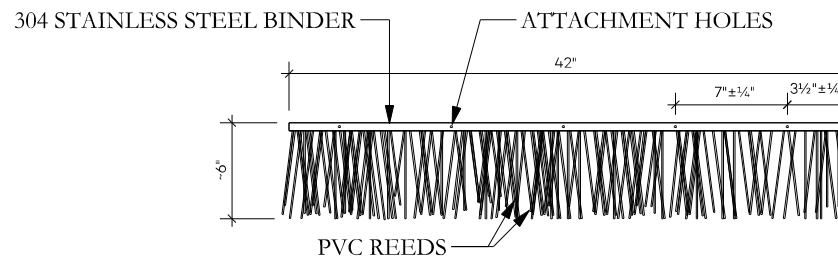

SOMERSET STARTER SHINGLE

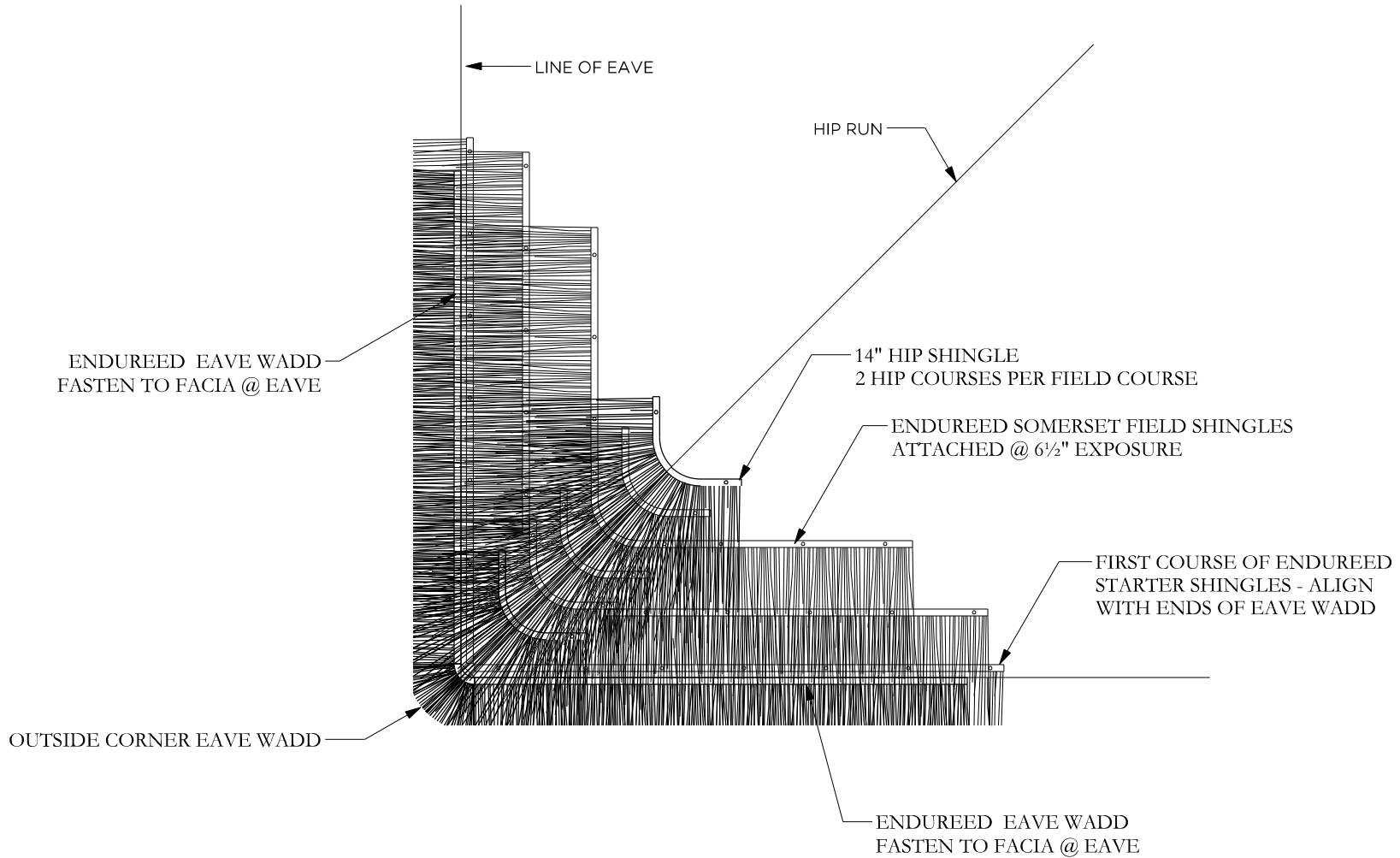

TRIMMED EAVE HIP ATTACHMENT PLAN

SCALE: 1" = 1'-0"

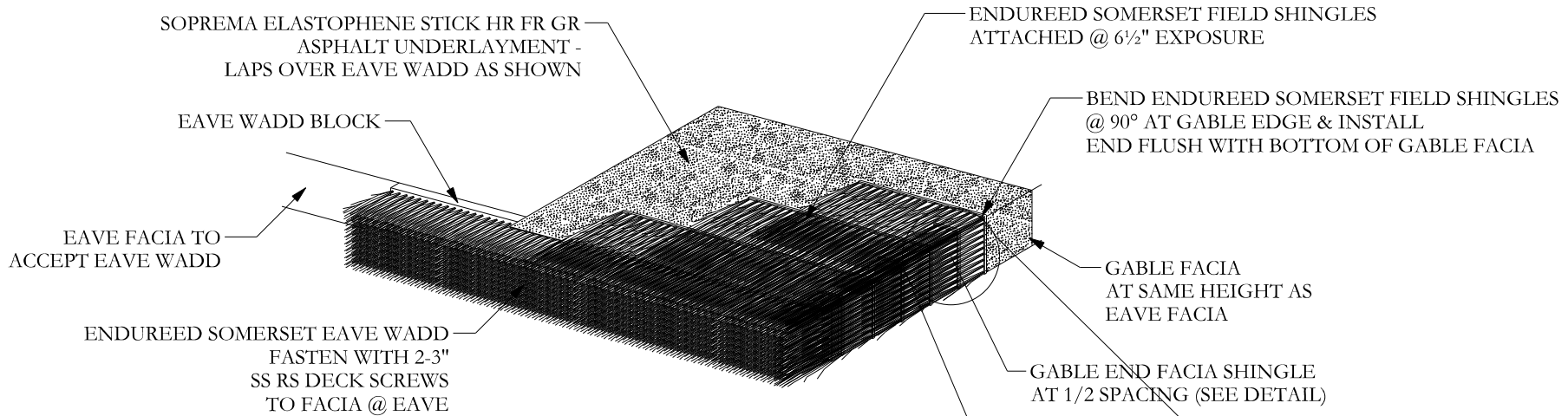

TRIMMED EAVE GABLE DETAIL

SCALE: 1" = 1'-0"

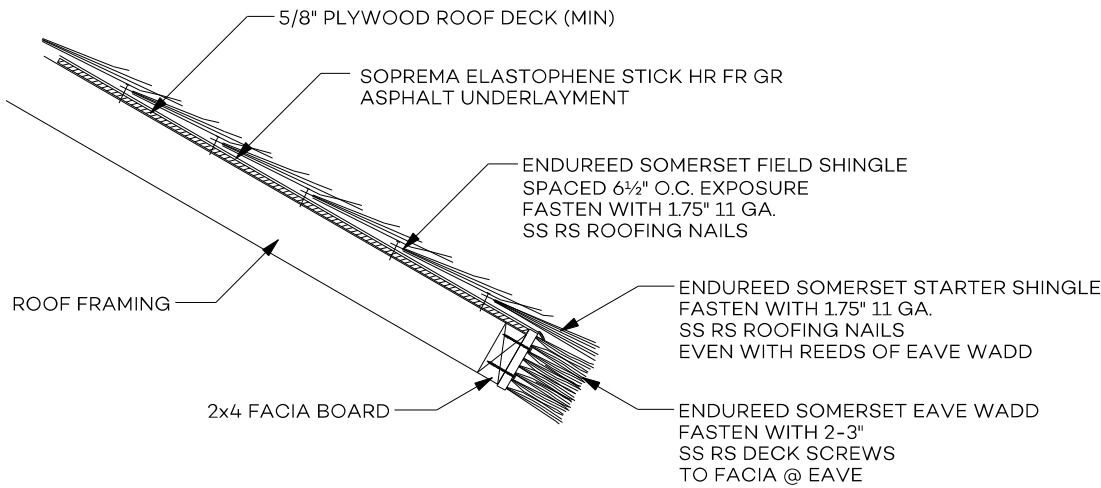

TRIMMED EAVE SECTION

SCALE: 1" = 1'-0"

GABLE END FACIA DETAIL

SCALE: N.T.S.

